



SEPTEMBER, 2023

PRODUCT KNOWLEDGE & TRAINING

New Westminster School District

ICS CLEAN SUPPLIES, BRITISH COLUMBIA

INFO@ICSCLEAN.CA | WWW.ICSCLEAN.CA | 1.888.577.7114

INTRODUCTION: WHAT IS EZ-MIX?

EZ-MIX is a comprehensive catalogue of cleaning chemicals designed in a compact, hyper concentrated, portion controlled bottle. Each **1.9L** bottle has a dilution control tip manufactured into the cap. All products include green certifications and are packaged in recyclable materials.

Each **EZ-MIX** bottle is pre-labelled with specific colors and numbers to match its designated system. All EZ-MIX bottles are compatible with **EZ-Mix™ Portable Chemical Dispensing System "HAND HELD"** or **EZ-Mix™ Wall-Mounted Chemical Dispensing System "CHEMIZER IV"**.

Enviro Care® Neutral Disinfectant

03

Proxi® Multi Surface Cleaner

20

DFE Sabre Floor Cleaner

24

Please refer to your labeled trigger sprayer bottle or labeled EZ-MIX 1.9L bottle for procedural and safety information

EZ-Mix™ Portable Chemical Dispensing System" HAND HELD"



EZ-Mix™ Portable Chemical Dispensing "HAND HELD" is designed with a quick connect and disconnect to allow for fast, mobile usage anywhere water is available.



1

SCREW ON EZ-MIX HAND-HELD DISPENSING SYSTEM

Remove 1.9L bottle cap and place the **EZ-MIX Hand-Held Dispensing System** on bottle, ensure the tips on the bottle and the tips of the dispensing system cap line up.

Screw on.

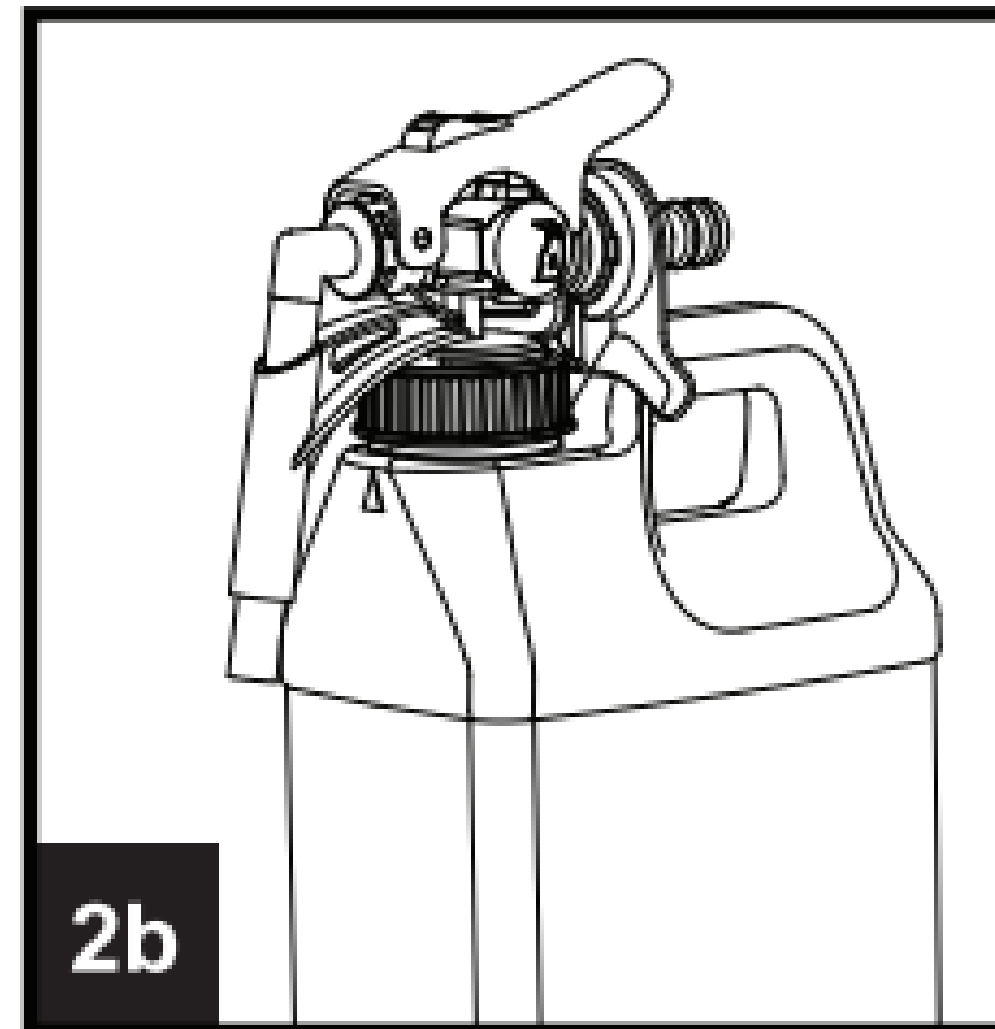
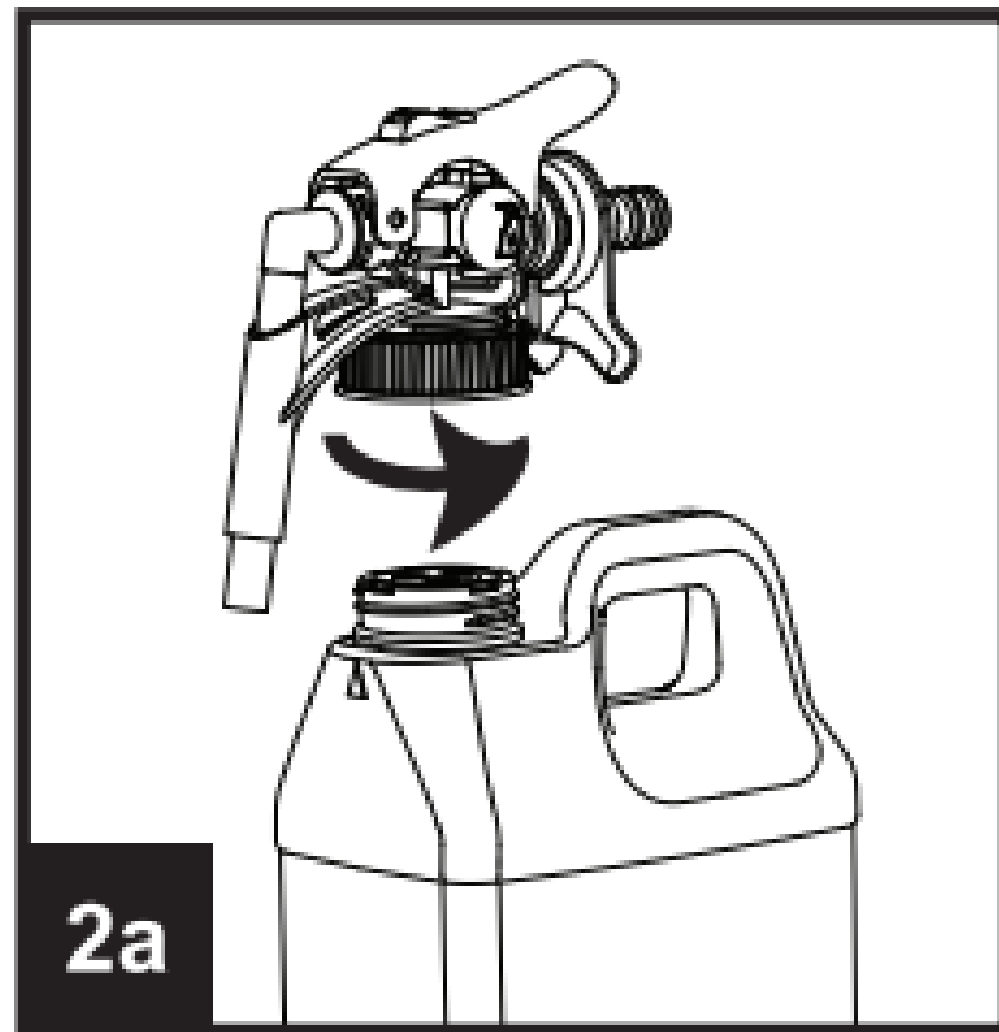

2

QUICK-CONNECT HOSE TO TAP & HOSE TO EZ-MIX DISPENSING SYSTEM

Attach one end of your Quick-Connect Hose to tap, attach other end to EZ-MIX Hand Held Dispensing System Cap. Once connected, **Turn On Water Supply- COLD WATER**

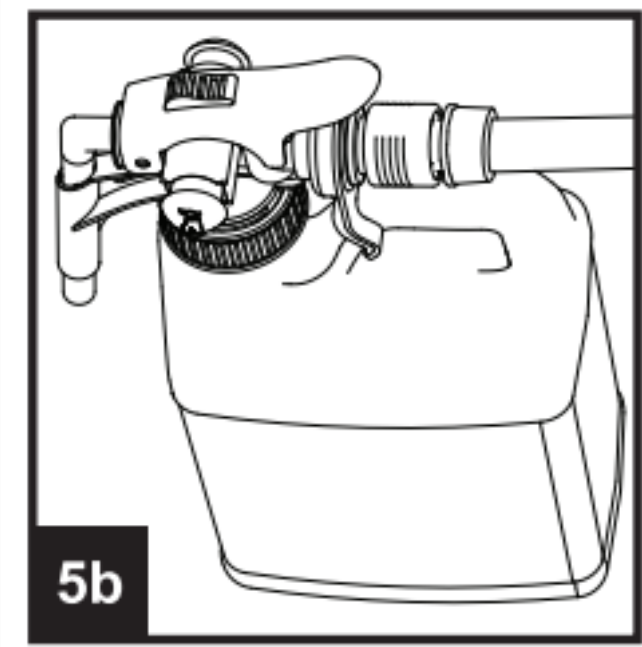
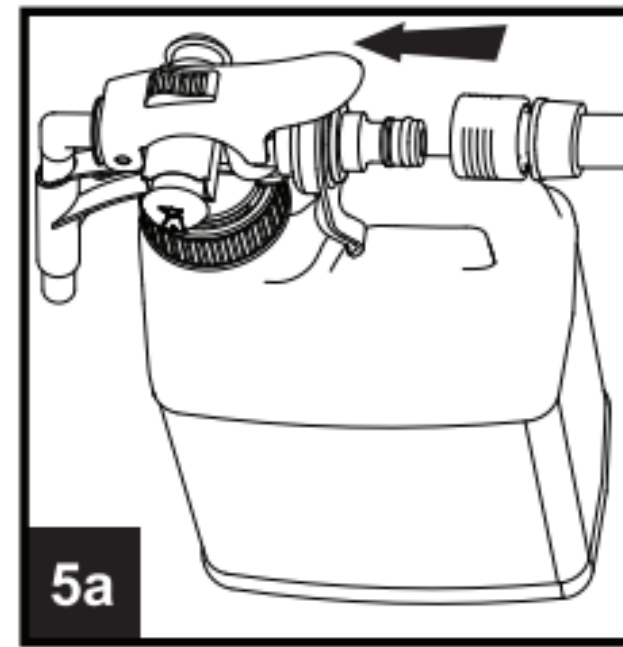
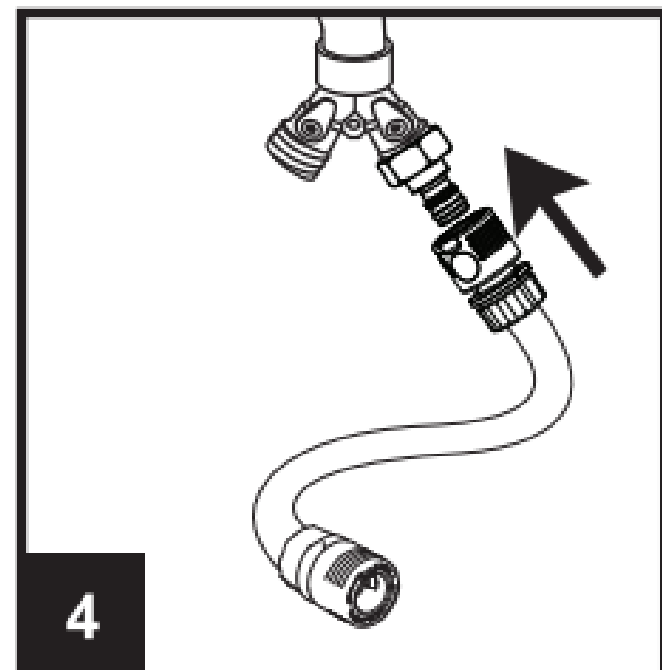
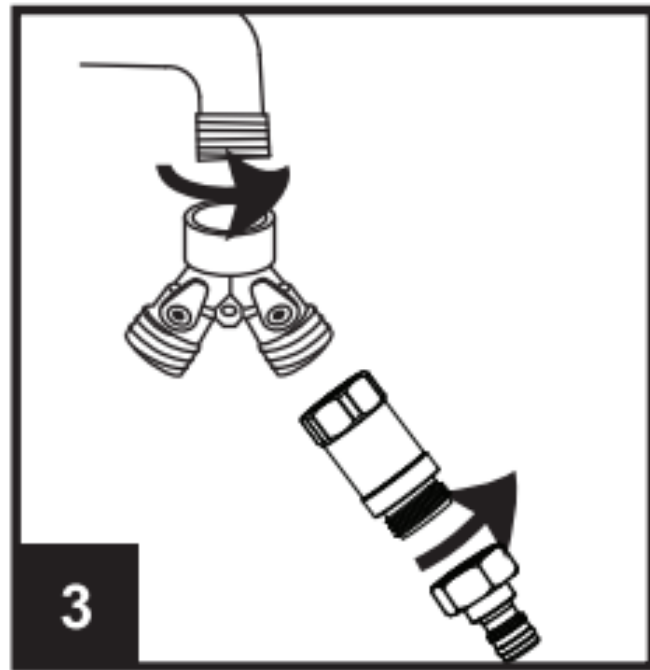

WARNING! ALWAYS SHUT OFF WATER SUPPLY WHEN NOT IN USE.

3

SLIDE GREEN BUTTON "LOCK" ON BUCKET OR BOTTLE FILL SETTING



BOTTLE FILL: This is the setting to fill all trigger sprayer bottles



BUCKET FILL: This is the setting to fill mop buckets & auto scrubbers.

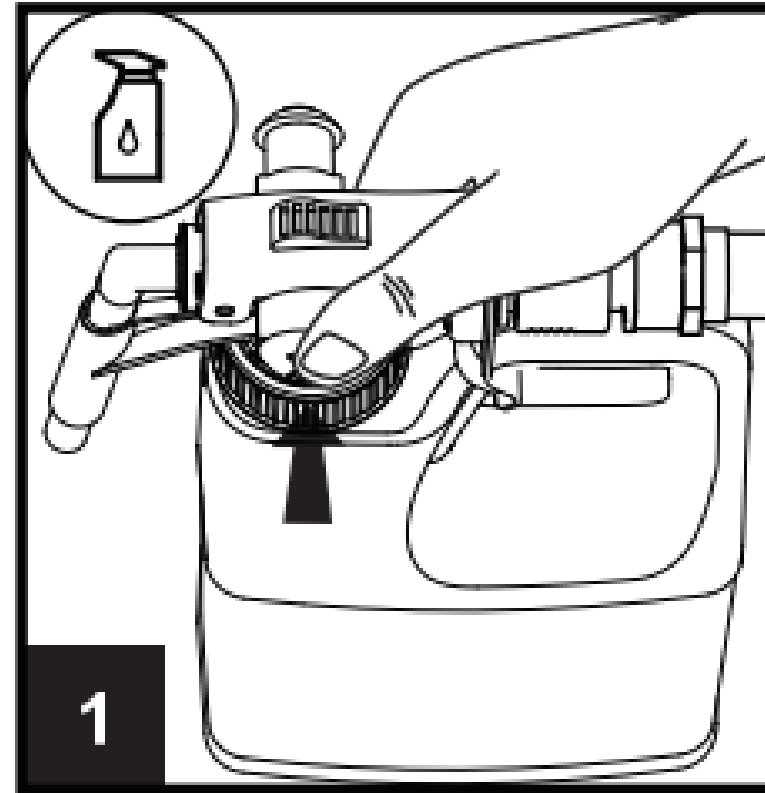

Push the spray bottle icon completely in for proper dispensing into a spray bottle.

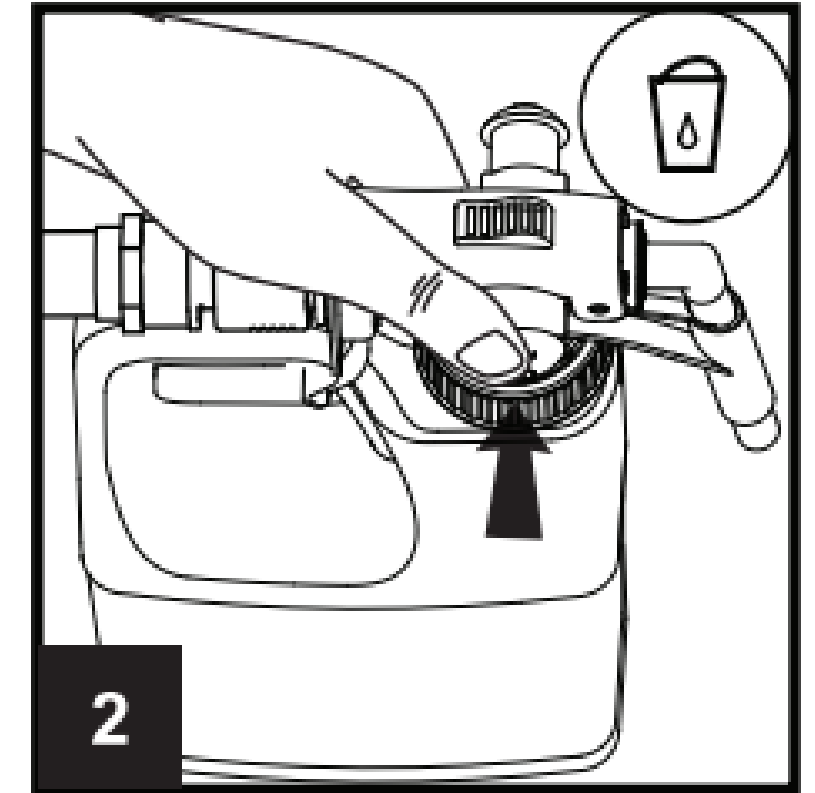
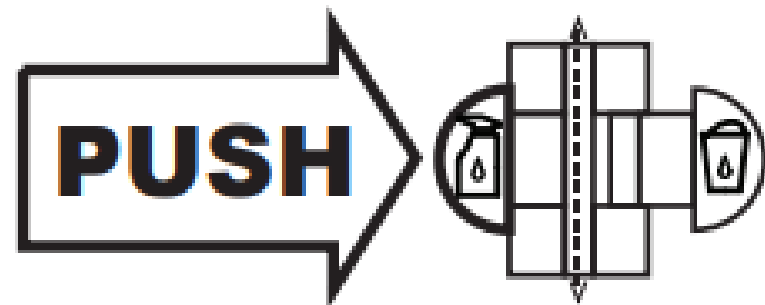

Push the mop bucket icon completely in for proper dispensing into a mop bucket.

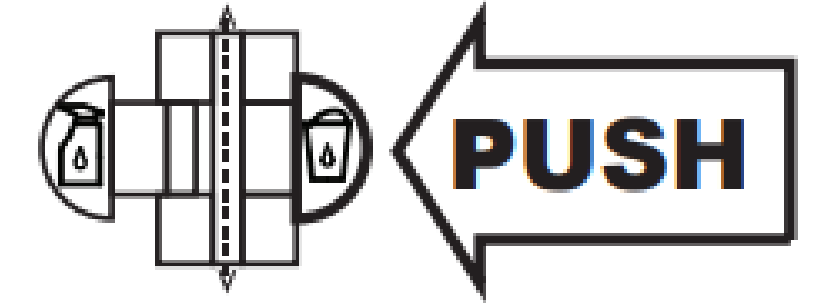

WARNING! ALWAYS SHUT OFF WATER SUPPLY WHEN NOT IN USE.

Press down on top lever to dispense solution. Once finished, shut off water supply.

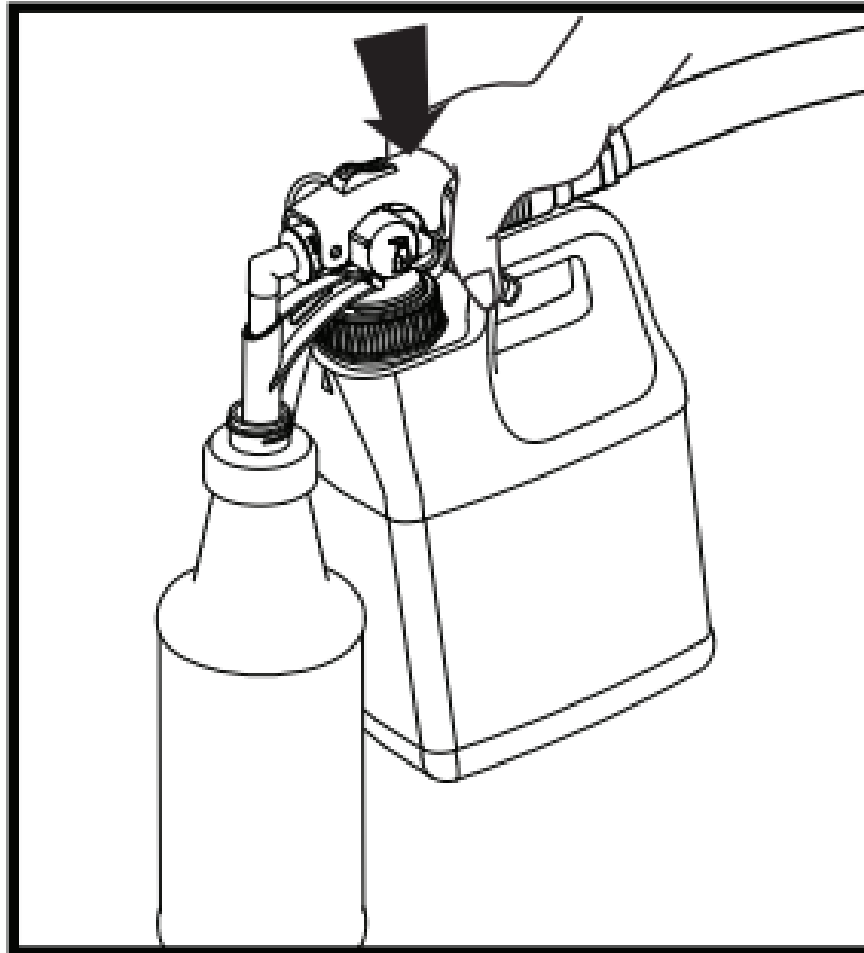

Push main water switch down to start dispensing for spray bottle.

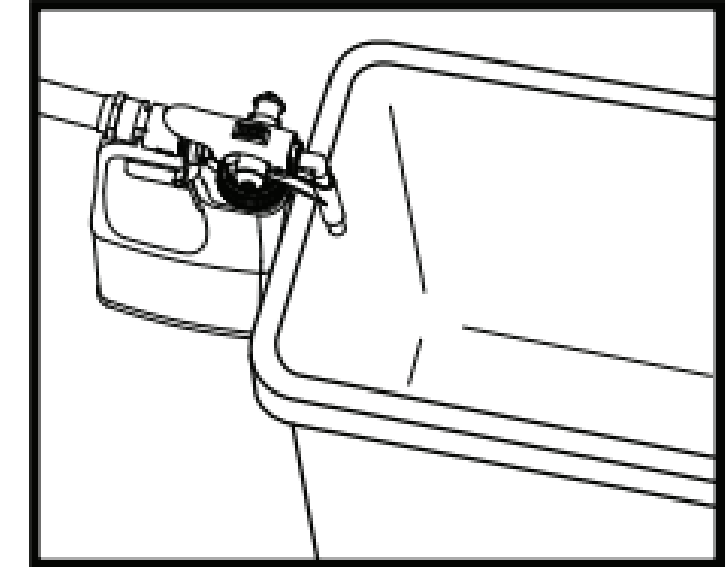
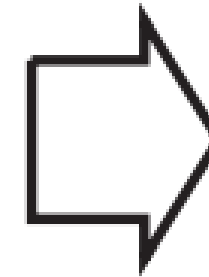
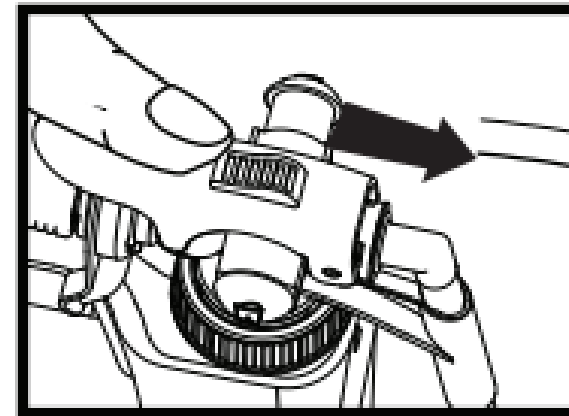
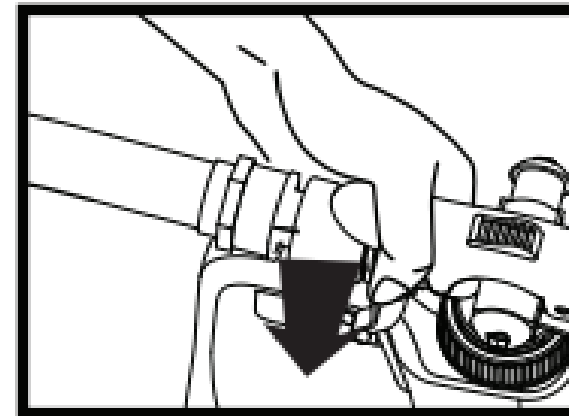

Push the main water switch down to start dispensing into a mop bucket. Slide holding lock forward to hold the main switch on for hands free operation.

WARNING! ALWAYS SHUT OFF WATER SUPPLY WHEN NOT IN USE.

EZ-Mix™ Wall-Mounted Chemical Dispensing System "CHEMIZER IV"

EZ-Mix™ Wall-Mounted Chemical Dispensing System "CHEMIZER IV" is a custom, locking cabinet to allow up to 4 EZ-MIX bottles to be dispensed through a "BUCKET FILL" or "BOTTLE FILL" push button setting.

The Chemizer IV has two PUSH BUTTON levers on top of the unit for Bucket Fill (RIGHT), or Bottle Fill (LEFT)

The Chemizer IV has two ARROW DIALS which are to be turned in the direction of the chemical you are wanting to dispense.

RIGHT ARROW DIAL- BUCKET FILL, LEFT ARROW DIAL- BOTTLE FILL

The Chemizer IV has two HOSES, one located in the middle for Bottle Fill, the second long hose for bucket and auto-scrubber fill.



BOTTLE FILL: This is the setting to fill all trigger sprayer bottles



BUCKET FILL: This is the setting to fill mop buckets & auto scrubbers.



1

REMOVE CAP FROM EZ-MIX BOTTLE AND SCREW ON TO MATING CAP INSIDE CHEMIZER IV CABINET

Each cabinet in the Chemizer IV will have a green **MATING CAP** connected to two hoses which will be screwed onto your EZ-MIX bottle, ensure the tips of the mating cap and EZ-MIX bottle align and tighten; always ensure bottle and cap are not cross-threaded.

NOTE: Each mating cap has an imprint on top, for proper mating of the cap and bottle ensure the imprint is facing the logo of your bottle.

Place bottle with **MATING CAP** affixed to the top in your **CHEMIZER IV**.

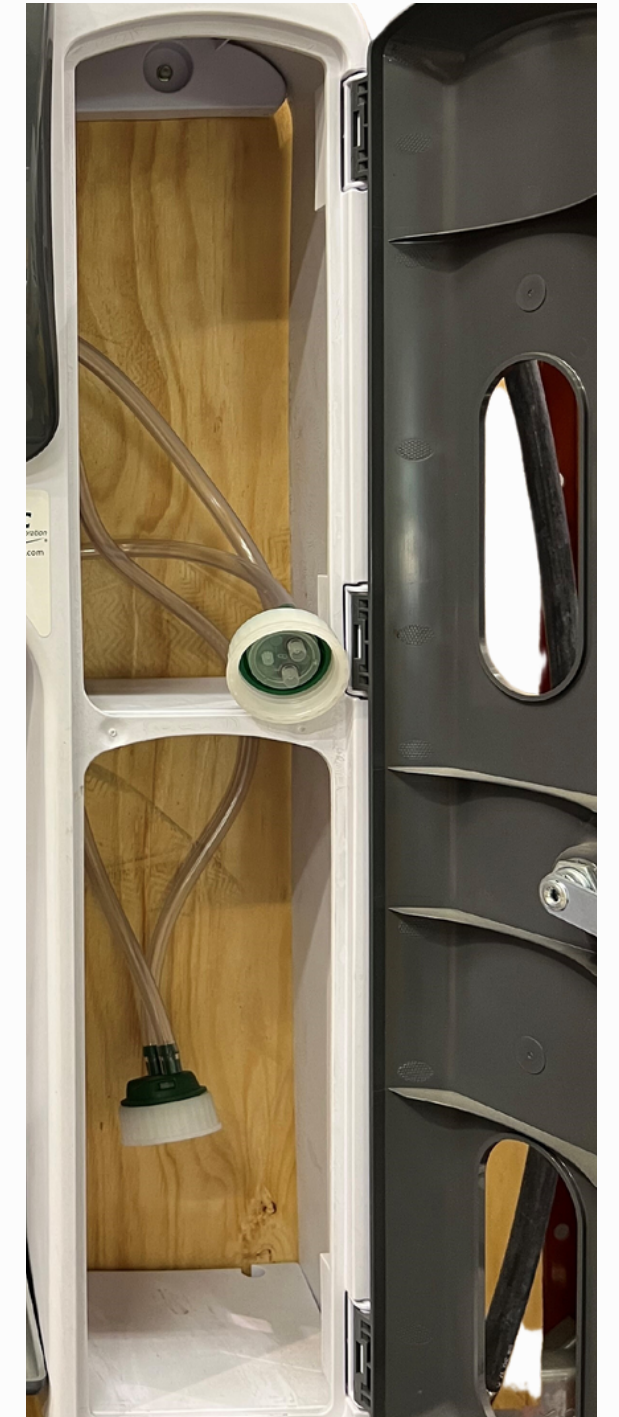

2

TURN ON WATER SUPPLY & PRIME CHEMIZER HOSES

Once your cabinet is prepared, turn on water supply—**COLD WATER only**. Always ensure your water supply is turned off when CHEMIZER IV is not in use.

BEFORE beginning your chemical dispensing, ensure hoses are PRIMED.

PRIMED: Begin dispensing (**HOLDING GREEN BUTTON**) to dispense solution through CHEMIZER IV hoses into your wash basin or spare bottle until chemical solution is visible in tubing of cabinet. See Red Circle.

Once chemical has made its way through tubing, proceed to Step 3.



Prepare your trigger sprayer bottle or bucket for dispensing. Ensure to only use the labeled trigger sprayer bottle that matches the chemical you are dispensing



4

POINT & TURN ARROW DIAL ON CHEMIZER IV TO FACE CHEMICAL YOU'RE DISPENSING

LEFT SIDE ARROW DIAL- This arrow dial is used for **BOTTLE FILL** only, as it is located under the BOTTLE FILL green push button.

Please note, the BOTTLE ICON located on the green push button.

RIGHT SIDE ARROW DIAL- This arrow dial is used for **BUCKET FILL** only, as it is located under the BUCKET FILL green push button.

Please note, the BUCKET ICON located on the green push button.



5

DISPENSE CHEMICAL INTO BOTTLE OR BUCKET.

After selecting your product with the green arrow, push and hold the top **GREEN BUTTON** to fill up your bottle or bucket.

As pictured, the **LEFT SIDE** arrow dial is pointing to the corresponding labeled EZ-MIX 1.9L bottle and the **LEFT SIDE** push button is being held for **BOTTLE FILL**.

Once complete, **SHUT OFF WATER SUPPLY**





Enviro Care[®] Neutral Disinfectant

CLEANER, DISINFECTANT & DEODORIZER

× × × ×

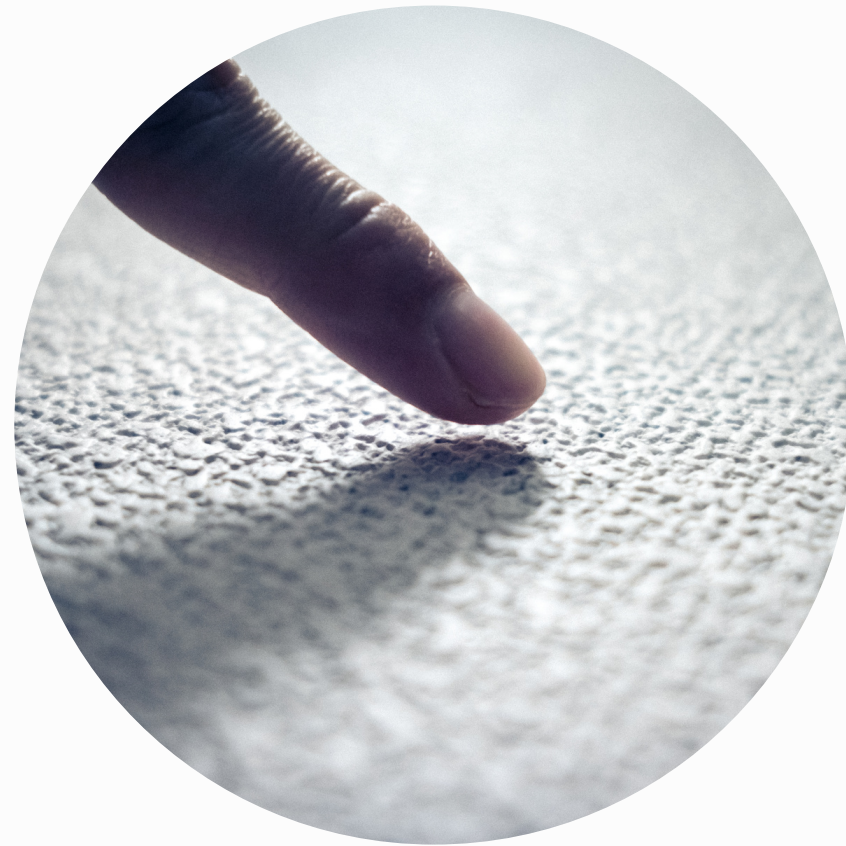

WHERE TO USE

Enviro Care® Neutral Disinfectant is a hospital-grade cleaner, disinfectant and deodorizer designed for use on:

ALL TOUCH-POINTS

WASHROOM FIXTURES

CLASSROOM DESKS

TOILETS & SINKS



03

FORMAT & APPLICATION

1.9L

Enviro Care® Neutral Disinfectant has a kill rate of less than 1 minute on surfaces. Effectively cleaning, disinfecting and deodorizing floors, walls, metal surfaces, stainless steel, porcelain, plastic surfaces and other hard, non-porous surfaces.

Always remove any heavy soil deposits from surfaces before application*

1 DISPENSE THROUGH DILUTION SYSTEM ON "BUCKET FILL" OR "BOTTLE FILL" SETTING

2 SPRAY ON, WIPE OFF

3 MOP ON SURFACE, LET DRY

4 NO RINSE REQUIRED*

PROPERTIES & BENEFITS

Enviro Care® Neutral Disinfectant is a universal, multi-functional product designed for high performance areas. This sustainable solution is **GREEN GUARD CERTIFIED** and is packaged in fully recyclable material.



Fragrance Free



**Biodegradable &
Phosphate Free**



**Hospital Grade
Disinfectant**



**Safe On All
Surfaces- Neutral
PH**





Proxi[®] Multi Surface Cleaner

GLASS, MIRRORS & GENERAL CLEANING

× × × ×





WHERE TO USE

Proxi® Multi Surface Cleaner is an accelerated hydrogen peroxide cleaner for mirrors, glass and designed for use on:

GLASS & MIRRORS

STAINLESS STEEL

SHOWER ROOM & WASHROOM

TILE & GROUT BRIGHTENING



20

FORMAT & APPLICATION

1.9L

Proxi® Multi Surface Cleaner is a versatile, multi-purpose cleaner formulated to remove stains, hard water build up and soap scum. This product perfectly cleans mirrors, windows, walls, restroom fixtures, and **specialty floor cleaning only***

Always remove any heavy soil deposits from surfaces before application*

1 DISPENSE THROUGH DILUTION SYSTEM ON "BUCKET FILL" OR "BOTTLE FILL" SETTING

2 SPRAY ON, WIPE OFF

3 MOP ON SURFACE, LET DRY

4 NO RINSE REQUIRED*

PROPERTIES & BENEFITS

Proxi® Multi Surface Cleaner is an accelerated hydrogen peroxide based cleaner designed for the toughest grime build up. This product is **GREEN SEAL CERTIFIED, GREEN GUARD CERTIFIED** and packaged in fully recyclable material.

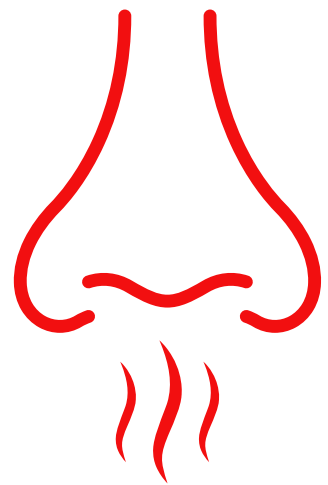

**Fresh, Cotton
Fragrance**



**Readily
Biodegradable**



DIN Registered

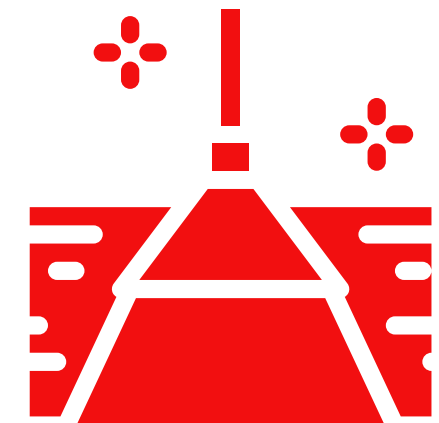

Carpet Pre-Spray





DFE Sabre Floor Cleaner & Degreaser

BIO-CATALYTIC FLOOR CLEANER & DEGREASER

× × × ×



WHERE TO USE

DFE Sabre Floor Cleaner is an industrial strength bio-catalytic floor degreaser and cleaner with odor counteractant properties designed for use on

GENERAL FLOORS

TILE & GROUT

KITCHEN FLOORS

WASHROOM FLOORS

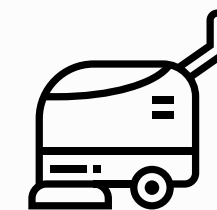

24

FORMAT & APPLICATION

1.9L

DFE Sabre Floor Cleaner & Degreaser is an industrial strength floor cleaner & degreaser with odour counteractant properties which quickly penetrates and digests fats, oils, greases and petroleum-based soils such as motor oil, hydraulic fluid, and lubricants. Its bio-catalytic properties serve as a waste digester, for continued odour control and oil breakdown on surfaces.

1 DISPENSE THROUGH DILUTION SYSTEM USING "BUCKET FILL" SETTING ONLY.

2 MOP ON SURFACE, LET DRY.

3 DO NOT USE ON GYM FLOORING

4 NO RINSE REQUIRED

PROPERTIES & BENEFITS

DFE Sabre Floor Cleaner & Degreaser is formulated with residual organic digestors to perform after application for continued odor control and oil breakdown on surfaces. This product is **USDA CERTIFIED, GREEN GUARD CERTIFIED** AND **ECOLOGO CERTIFIED**, packaged fully in recyclable materials

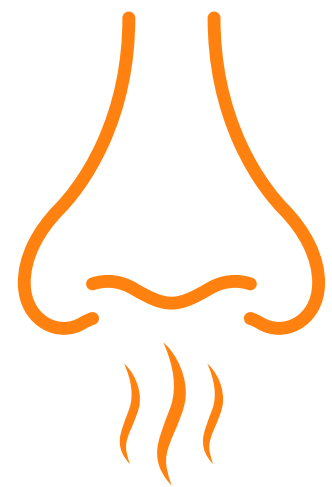

Floral Fragrance



Biodegradable & Phosphate Free



Contains Live Bacterial Cultures



Leaves Non-Slip Coating





Jiffy, Cleaner & Stain

Remover

READY-TO-USE, VERSATILE SPRAY CLEANER

× × × ×

WHERE TO USE.

Jiffy, Cleaner & Stain Remover is a powerful formula that will quickly remove most detergent-resistant marks and stains formatted in a ready-to-use bottle.

WALLS & FLOORS

KITCHEN APPLIANCES

PLASTIC & CERMAIC TILE

BATHROOMS

FILING CABINETS

STAINLESS STEEL

CLASSROOM DESKTOPS

VARNISHED SURFACES

FIBREGLASS

PORCELAIN ENAMEL

× × × ×

WHAT DOES IT REMOVE?

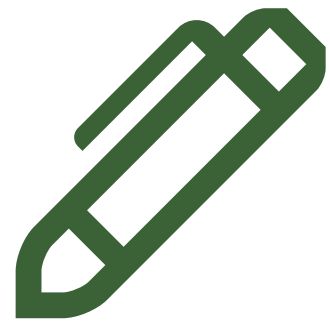

Ball Point Ink



Fingerprints

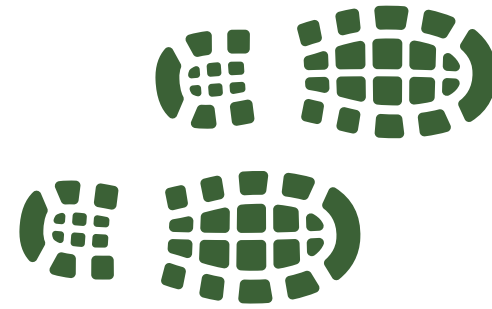

Black Heel Marks



Oil & Grease Stains

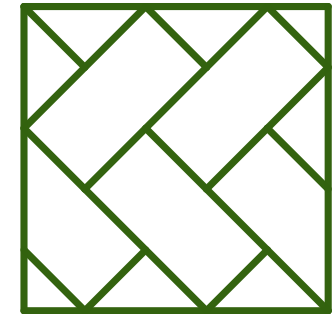

Dried Floor Finish

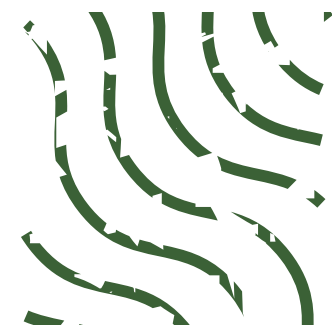

Scuff Marks

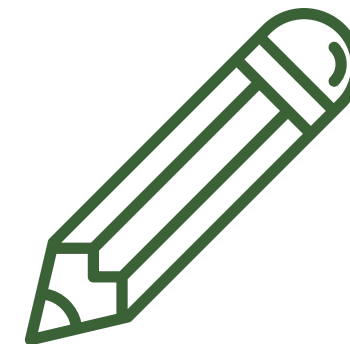

Pencil & Crayon Marks



FORMAT & APPLICATION

946ML

1 HOLD READY-TO-USE BOTTLE 6 TO 8 INCHES AWAY FROM SURFACE

2 SPRAY SURFACE UNTIL WET

3 WIPE SURFACE DRY WITH CLOTH, SPONGE OR TOWEL



DFE 401, GENERAL

PURPOSE CLEANER

NEUTRAL, BIODEGRADABLE MULTI-PURPOSE CLEANER

x x x x





PROPERTIES & BENEFITS

DFE 401 has been formulated to be safer for product users and building occupants comprised of a complex blend of biodegradable surfactants. This product is **ECO LOGO CERTIFIED** and packaged in 100% recyclable materials.

NEUTRAL PH . LOW SUDSING . PHOSPHATE FREE . LEMON FRAGRANCE. HIGHLY DILUTABLE . BIODEGRADABLE



WHERE TO USE

DFE 401 is a heavy-duty general purpose, neutral cleaner formulated to be safe on all washable surfaces. To be used on:

GYM FLOORING

ALL WASHABLE SURFACES



FORMAT & APPLICATION

3.78L

1 DILUTE DEPENDING ON SOIL. LIGHT SOIL, MEDIUM SOIL OR HEAVY SOIL

2 MIX WITH COLD WATER ONLY

3 APPLY WITH MOP, SPRAY & WIPE OR AUTOSCRUBBER



LIQUI BAC, ENZYMATIC CLEANER & DEODORIZER

**DRAIN & TRAP TREATMENT CLEANER, INSTANT
DEODORANT**



WHERE TO USE

Enviro Care Liqui Bac, Enzymatic Cleaner & Deodorizer is a triple acting enzyme-producing living liquid bacteria product with instant odor control. Liqui Bac breaks down and liquefies solids such as fats, proteins, carbohydrates and grease. Ideal for on-going drain and grease trap maintenance.

CARPET & CARPET SPOTTING

ORGANIC DIGESTOR

DRAIN & URINALS

GREASE TRAPS

WASHROOM & SHOWER ROOMS

URINE & PET STAINS



PROPERTIES & BENEFITS

Enviro Care Liqui Bac, Enzymatic Cleaner & Deodorizer contains aerobic and anaerobic bacteria to immediately neutralize all malodors and remains 100% active until their work is done, at which time they begin rebuilding colonies resulting in a successful ongoing maintenance. This product is **ECOLOGO CERTIFIED** and **USDA CERTIFIED** packaged in 100% recyclable materials.

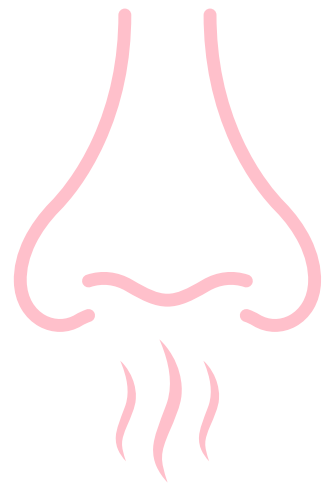

Floral Fragrance

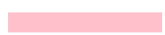

Biodegradable & Phosphate Free

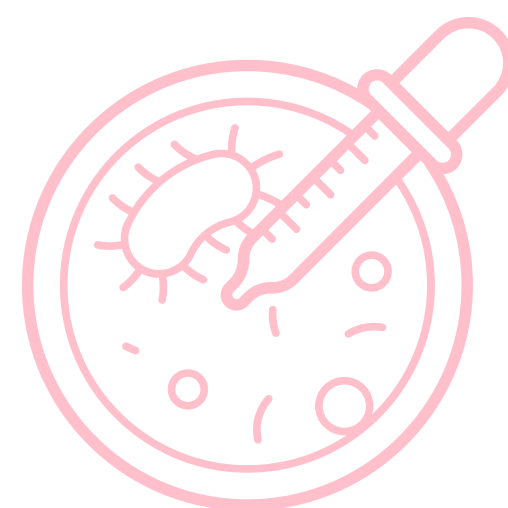
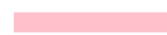

Contains Live Bacterial Cultures

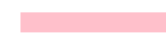

Non-Toxic

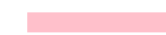

FORMAT & APPLICATION

3.78L or 946mL

1 DRAIN , URINAL & TRAP TREATMENT

- **For treating sluggish drains or grease traps, measure 4oz of product, pour directly into drain, urinal or grease trap- let stand for 30 minutes & repeat once a week for routine maintenance.**

2 CARPET DEODORIZING & ORGANIC WASTE DIGESTOR

- **Spot clean and vacuum carpet. Dilute as per bottle instructions, apply with sprayer or pump & keep moist for approximately 30 minutes. Repeat if necessary. Can be used with carpet cleaning equipment.**

3 CARPET SPOTTING

- **Dilute 12oz per gallon of water, spray on organic stain and let stand for 10-30 minutes. Damp clean or extract area.**

MICROFIBER BENEFITS VS COTTON

1 MORE EFFECTIVE IN MICROBIAL REMOVAL

2 BETTER CLEANING PERFORMANCE & DURABILITY

3 LESS LINTING, DOES NOT LEAVE RESIDUE

4 QUICKER ABSORBING AND DRYING

5 HOLDS MORE DIRT, LIQUID AND OTHER CONTAMINANTS

4-SIDE MICROFIBER WIPER METHOD

1

**FOLDING THE CLOTH IN HALF,
THEN HALF AGAIN WILL
PROVIDE YOU 8 CLEANING
SURFACE OPPORTUNITIES.**



2

**USING ONLY ONE SIDE AT A
TIME WILL MAXIMIZE THE USE
OF YOUR MICROFIBER CLOTH.**



PSA

**WASH YOUR MICROFIBER CLOTH OUT WITH
WARM TO HOT WATER TO REMOVE DIRT &
BACTERIA BETWEEN CLASSROOMS OR CLEANING
TASKS.**



MICROFIBER COLOR CODES



WHY: Following this system will eliminate any risk of cross-contamination through your facilities; cleaners **MUST** use this color coded system when cleaning all surfaces.

GRAY CLOTH: General Purpose Surfaces, Classrooms, Desktops

ORANGE CLOTH: Washrooms ONLY

BLUE CLOTH: Glass & Mirrors ONLY